

Installation instructions

Viken hardened wood floors

Our hardened wood floors feature unique designs for you to explore and are available right up to luxurious XXL formats. Our entire range features the incredible patented Woodura™ surface technology and 5G™ Dry™ fold down system – making our real wood floors 3 - 5 times stronger than traditional hardwood floors and a breeze to install – all at a great price.



Licensed by

woodura™



Woodura and 5G Dry are patented technologies invented by Välinge Innovation AB. The logos are trademarks owned by Välinge Innovation AB and authorized use of such marks are under license.

VIKEN®

us-sales@bjelin.com

Floating installation of hardened wood flooring with mechanical joint

Please thoroughly read the entire instructions before laying the floor.

Preparations

The room and the boards must have a temperature of at least 18° C (64° F). Keep in mind to spread the bundles out so that they quickly get into the ambient room temperature.

Be sure to inspect each board before laying. If you have hired a professional, he must also read the entire instructions before laying. Viken doesn't take responsibility for obvious defects or losses that could have been discovered prior to installation. Viken boards are normally laid floating but can also be glued down (see separate instructions). In the case of gluing down, we recommend that you contact a specialist.

Open 2 - 3 bundles at a time and mix the boards as you install the flooring. This will help you to get an idea of the variation before laying.

Hardened wood flooring is laid floating, i.e. joined together without being attached to the subfloor.

- The subfloor must be dry, flat, firm and clean.
- Carpets shall be removed.
- When installing on expanded polystyrene, see special instructions.
- Hardened wood flooring can be laid on underfloor heating and the heating system must provide an efficient and even heat distribution over the entire floor. Surface temperature of the floor must never exceed 27° C (80° F) (also applies to pipes to radiators and under carpets etc.).
- Check subfloor flatness at 2 m (6 ft) measurement length and at 0,25 m (1 ft) measuring length. If the unevenness is greater than ± 3 mm (1") at 2 m (6 ft) measurement length or greater than $\pm 1,2$ mm (1/4"), at 0,25 m (1 ft) measurement length, they must first be levelled. Even ± 2 mm (1/4") at 1 m (3 ft) measuring length is accepted.
- The relative humidity of the room must not exceed 60% RH. If RH is less than 30%, there is an increased risk of concave boards and gaps between boards. At low RH in the air you can use a humidifier to add moisture.
- Wooden floors should in most cases be protected against moisture from the subfloor. We recommend in the first place Vikens floor underlay Kombi, which is a combined vapour barrier and foam for best results. You can also use a 0,2 mm (6 mil) age-resistant polyethylene film, applied with 200 mm (8") overlap in combination with foam or cotton/rag paper/hard board. In markets where these products are not available, please contact your local Viken representative for approved products. Please note that on subfloors of newly casted concrete, lightweight concrete, concrete floors directly on the ground, crawl space foundations, on joists over hot or humid rooms (e.g. boiler room or laundry room) or underfloor heating systems, damp proofing is mandatory.
- The subfloor must be well cleaned and dry to avoid mold. In most cases, this means vacuuming the subfloor.
- When using a separate vapour barrier, use a foam on top to reduce step noise. Use a (2 mm) 0.08 - 1/4" polyethylene or polyurethane foam of approved quality (com-

pressive strength of at least 60 kPa) or cotton/rag paper. The interlayer is laid edge to edge. At nominal requirement of sound reduction, contact a sound expert.

- If the RH in the substrate is between 90 - 98%, an air gap-forming moisture barrier, such as Platon or Matak, should be used. Note that at least a 6 mm thick tongue and grooved load-distributing sheet, such as a wood fibre or chipboard, should be placed on top of the moisture barrier. Note: these products are not available in the US.
- The boards must be laid lengthwise in the room. The floor moves with varying humidity and should therefore usually have a minimum expansion gap of 10 mm (3/8") against walls and fixed objects (stairs, columns, door frames, etc.) for easy and smooth installation. It is also possible to calculate the size you need and then you should count on 1,5 mm (1/6") expansion gap per metre for every 76,2 mm, (3 ft) of floor width. This expansion gap must be around the entire floor against the wall and other solid objects. Bear in mind it is enough that 1 cm (3/8") of your newly laid floor is touching another surface, such as a wall, for the floor's ability to move to cease. Rooms up to 25 m (80 ft) wide and 25 m (80 ft) long can be laid in one continuous surface. If the floor is larger, you should divide it. Floors must be divided in doorways with an expansion gap. Cover the expansion gap with a molding. When laying in L, T or U-shaped rooms and when transitions to corridors, an expansion gap must be installed.
- A skirting board or T-moulding needs to be 50% thicker than the expansion gap. Example: if you have calculated that you need an 8 mm (1/4") movement joint between the floor and the wall the skirting should be at least 12 mm (1/2").

Installation

First calculate how many board rows you need on the width of your room. If the last board is narrower than 40 mm (2"), also the first row should be sawn so that the starting and finishing boards are the same width. This makes for a neater installation. Keep in mind that it is easiest to start at the long wall with the most doors. If there are doors on the short side, start the row there. The boards can be installed from the left and from the right, but also backwards.

You should always install wood floors with at least one short end in every second row. This also applies to more compact spaces such as hallways or smaller rooms. An even distribution of short ends allows the floor to remain level in case of temperature changes.

Use wedges to create the right distance between floor and wall. These allow for a movement gap of at least 10 mm (3/8") towards the wall and other solid objects. Boards should be laid in the length of the room.

Finally, remove the wedges and cover the gap between the wall and the floor with a skirting board or cover strip. A finishing strip or T-moulding is used to join wood floors and other flooring materials. Install mouldings so that the floor can move with seasonal variations.

If you come across a damaged board, put it aside. It may be left over or can be used at the finish. Of course, you can also exchange it where you bought it. The installer is responsible for ensuring that boards with obvious defects are not installed.

Thickness of skirting board

Remember that it is the movement of the floor that determines the thickness of the skirting board and not the other way round.

- Larger floors need larger movement joints which means thicker skirtings.

Tip: If you are renovating or building a new house, an easy way to avoid thick skirtings is to put the wall panelling a little higher up, allowing the floor to move underneath. See picture B.

How to calculate the thickness of the skirting board

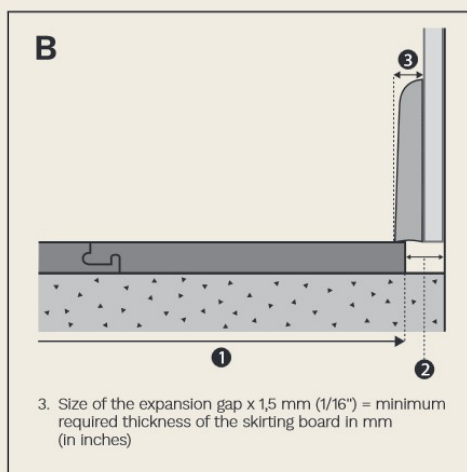
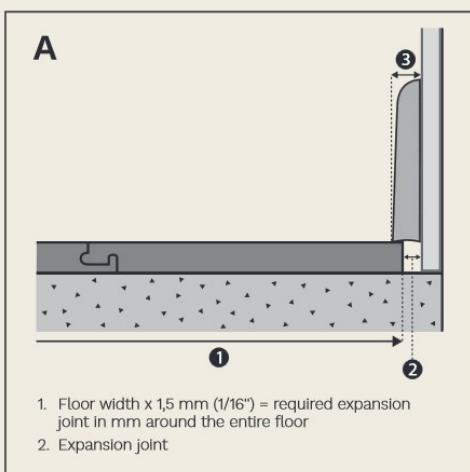

Make sure the boards can move freely under the sheets.

Minimum thickness of the expansion gap and skirting board at different floor widths

FLOOR WIDTH 1	EXPANSION GAP 2	SKIRTING BOARD WIDTH 3
4 m (13.1 ft)	6 mm (1/4")	15 mm (3/8")*
6 m (19.7 ft)	9 mm (3/8")	15 mm (5/8")*
8 m (26.2 ft)	12 mm (1/2")	18 mm (3/4")*
10 m (32.8 ft)	15 mm (5/8")	22 mm (7/8")*
12 m (39.4 ft)	18 mm (3/4")	27 mm (1")*
15 m (49.2 ft)	22 mm (1")	33 mm (1 1/2")*
18 m (59.0 ft)	27 mm (1")	40 mm (1 1/2")*

*For easy installation, the minimum recommended expansion gap is 8 - 10 mm (5/16 - 3/8")

Floor cover

The basic rule is that the wooden floor should be laid last in the construction in order to avoid damage. If further work is to be done in the room where the floor has been laid, the floor must be protected with a material that allows moisture to pass through (e.g. hard paper/ram board). Also check that the cover does not discolour the floor or leave

residues such as wax. Do not tape against the wood floor but only against each sheet of protective covering. Many tapes adhere so hard to the floor surface that the coating detaches when the tape is removed. The longer the tape is left in place, the greater the risk that it will stick harder to the finish.

Instructions

1

Start by removing/sawing off door liners/frames so that the floor can be pushed underneath which gives a neat and professional result. The easiest way is to use a multi-tool or a hand saw. Use a board turned upside down with underlay as a template to get the right height. Remember not to lock the floor against or under the door frame.



2

Start in a left corner, and place the first boards under lip out towards the room on both the long and short side. The long side distance to the wall can be adjusted later when 3 rows have been laid.

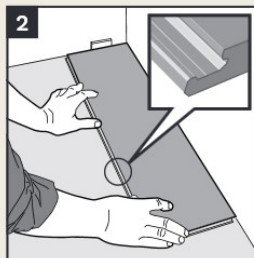

3

The next board is placed with the short end against the first board's short end. Press the short end down so that it clicks into place. Continue in the same way along the entire first row.

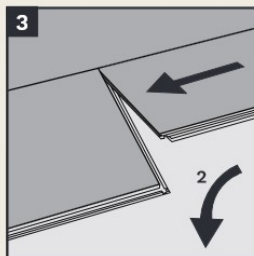

4

Cut the last board in the first row to the correct length. Do not forget the expansion gap around the floor.

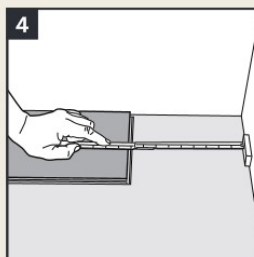

5

Start the next row with the piece left over from the previous row.

The short ends in adjacent rows must be separated with at least 400 mm (16") on boards above 1500 mm (59") long. Boards shorter than 1500 mm (59") shall have a short end separation of at least 300 mm (12").

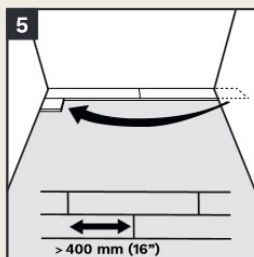

6

Press the long side of the new board into the already laid board so so that the joint is tight. Then lightly press the board downwards at the same time as you gently tap with your hand so the board will easily fall into place. Be careful when tapping them together so that nothing is damaged. Make sure you do not have any debris such as sawdust in the joint, as this can prevent or damage the board if it is forced together. Continue laying the remaining rows in the same way.

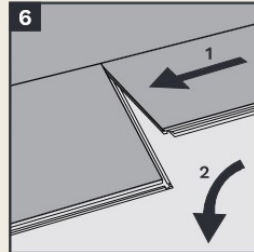
**7**

Once three rows have been laid, the distance between the floor and the walls can be adjusted. Place wedges between the floor and the wall. When the floor is finished remove the wedges.

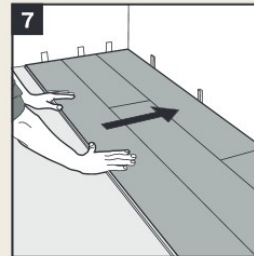
**8**

The first row of boards must sometimes be adapted to a crooked wall. Draw the contour of the wall on the boards. Then loosen the boards in the first row by grabbing the long side, pulling upwards and at the same time hitting the joint lightly. Saw after your line.

For best results it is sometimes necessary to split the first board so that the first and last board get the same width to avoid that the last board becomes too narrow.

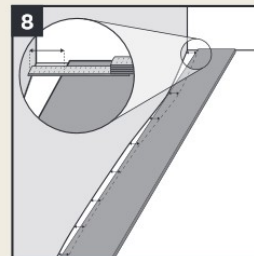
**9**

The last row: measure the exact width of the last row. Do this: Place the last board on top of the second to last board row with about 7 mm (3/8") offset to the wall. Mark the saw cut using a piece of board without a bottom lip. Lay the last board. Sometimes you may have to gently help the last board with a last board puller or crowbar to get it into place.

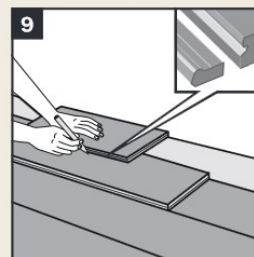
**10**

For pipes, holes are drilled in the board which must be at least 20 mm (3/4") larger in diameter than the pipe. Saw as shown in the pictures. Glue the cut piece again. Remove excess glue immediately. Cover the holes with pipe sleeves.

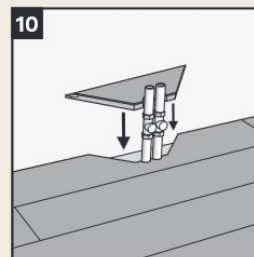

11

If you can't angle in the board underneath e.g. door linings or sills, do like this: Cut/plane away the locking joint with a chisel or hand planer. Glue on the bottom lip with a Pvac glue (D3) and lay the boards. Use wedges to press the board into place while the glue dries.

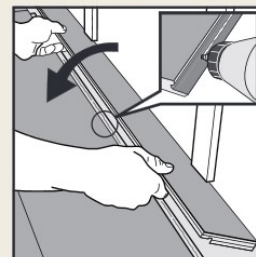
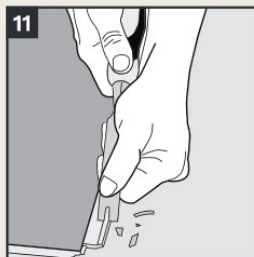
**12**

If you need to pick up a laid board, the easiest is to use Viken's special tools, which you push into the joint on the short side, so that the locking joint releases. With this tool you can remove single boards without loosening the whole row.

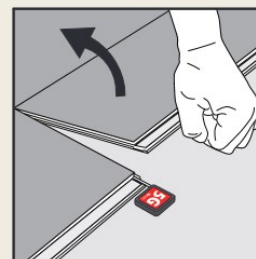
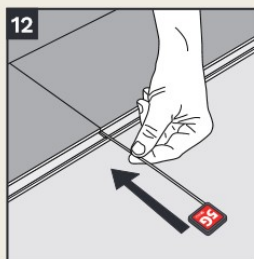
**13**

If you do not have this tool and need to pick up a board after laying, you can angle up a whole board row along the long side at a time. Dismantle the short sides by pushing them apart horizontally. It is also possible to angle up the short side of the 5G Dry.



Installation backwards

1

When you lay backwards, you lay from left to right. Angle your under lip under the previously laid row and fold down.

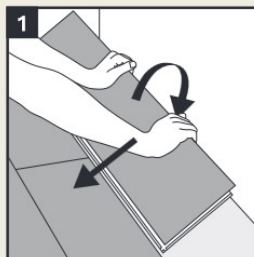
**2**

Angle the next board in under the laid row and slide it against the short side of the adjacent board and lay down. Gently press the short end of the board until you hear a click, which means it has locked.

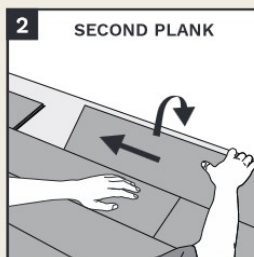

Care and maintenance of our floors

Viken wood floors are easy to maintain. Daily maintenance is easiest done by vacuuming and occasionally cleaning it with a well wrung-out cloth. Be careful not to damp mop too often and with too much water as wood is sensitive to water. When you damp mop the floor, it should be dry within 2 - 3 minutes, then you know that you have used the correct amount of water.

If you use too much water, the floor may be damaged.

If you accidentally spill, it won't leave a mark on your floor if you just wipe it up immediately.

Place a drying mat outside and inside the front door so you don't get a lot of dirt and grit in that would otherwise wear

hard on your floors. So be careful not to get it on your Viken floor and it will last for many years to come.

Putting soft felt pads on the furniture is recommended, as you avoid unnecessary marks and scratches on the floor.

If you get a stain on the floor, see the table below.

Be careful with strong stain removers. If too much is used and rubbing is done too hard, it can affect the lacquer or oil on your floor.

For a more detailed maintenance instruction see bjelin.com.

Factory lacquered surfaces

STAINS OF	REMOVED WITH
Asphalt, rubber, oil, shoe polish, soot and dried residues of chocolate or fat	Bona Kemi Deep Cleaner diluted in water, cleaning spray, benzine or similar
Crayons, lipstick, markers	Cleaning alcohol diluted 50/50 with water
Stearin, chewing gum	Cool spray or place a bag of ice cubes on the stain, then gently scrape
Blood	A neutral detergent diluted in water

Factory oiled surfaces

STAINS OF	REMOVED WITH
Asphalt, rubber, oil, shoe polish, soot and dried residues of chocolate or fat	Bona Kemi Deep Cleaner diluted in water, cleaning spray, benzine or similar
Crayons, lipstick, markers	Cleaning alcohol diluted 50/50 with water
Stearin, chewing gum	Cool spray or place a bag of ice cubes on the stain, then gently scrape
Blood	A neutral detergent diluted in water

Oiled surfaces are sensitive to strong detergents and heavy cleaning. After spot cleaning the oiled surface may need touch-up oiling.

For more information on maintenance, care & repair see our website www.bjelin.com

Glue down

When glue down application is required, please see special instruction at <http://www.bjelin.com>.





Checklist:

- Remove all skirting boards
- Remove or saw off door linings and sills
- Leave proper clearance between the floor and all fixtures objects such as walls, sills, columns or pipes
- The floor should always be laid in the longitudinal direction of the room. If the room is roughly square, you can choose the direction of the floor

📌 When gluing to the subfloor, see special instructions at bjelin.com



Recommended tools and equipment:

- Safety glasses
- Approved dust mask
- Vacuum cleaner
- Laying wedges
- Saw
- Pencil
- Measuring tool
- Set square
- Maybe a moisture barrier
- Wood glue (D3)

Wood dust

Sawing and sanding wood produces wood dust.

Preventive measures:

- Equipment should be equipped with a dust collector to reduce airborne dust.
- Use appropriately designed protective mask to reduce exposure to airborne wood dust.
- Avoid eye and skin contact.
- In case of irritation, flush eyes and skin with water for at least 15 minutes.
- In case of severe discomfort, seek medical attention immediately.



woodura™



VIKEN®

Woodura and 5G Dry are patented technologies invented by Välinge Innovation AB. The logos are trademarks owned by Välinge Innovation AB and authorized use of such marks are under license.

us-sales@bjelin.com



woodura™



VÄLJEN

Woodura and 5G Dry are patented technologies invented by Välinge Innovation AB. The logos are trademarks owned by Välinge Innovation AB and authorized use of such marks are under license.

us-sales@bjelin.com

